

ECQ

Motor size U



Electronically commutated motors for the drive of fans

Assembly instructions

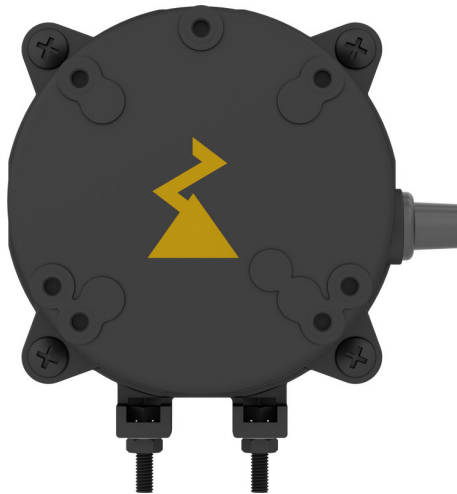

Keep for reference!

Content

- 1 General notes 3**
 - 1.1 Validity 3
 - 1.2 Structure of the assembly instructions 3
 - 1.3 Target group 3
 - 1.4 Exclusion of liability 3
 - 1.5 Copyright 3

- 2 Safety instructions 4**
 - 2.1 Explanations of symbols 4
 - 2.2 Product safety 4
 - 2.3 Requirements placed on the personnel / due diligence 5
 - 2.4 Work on the device 5

- 3 Product overview 6**
 - 3.1 Application operational area 6
 - 3.2 Functional description 6
 - 3.3 Motor protection 7
 - 3.4 Transport, storage 7
 - 3.5 Disposal / recycling 7

- 4 Installation 8**
 - 4.1 Mounting the motor 8
 - 4.2 Connection lead & terminal box 9
 - 4.3 Connection of the motor 10

- 5 Start-up 11**

- 6 Service work 12**
 - 6.1 Repairs / maintenance 12
 - 6.2 Cleaning 12

- 7 Enclosure 13**
 - 7.1 Technical data 13
 - 7.2 EU declaration of conformity 15
 - 7.3 Manufacturer: 17
 - 7.4 Service address 17

1 General notes

1.1 Validity

This document is valid for ECQ motors of motor size **U** (060) with the following type designations (see rating plate):

MI060-4QN.05.N1, MI060-4QN.05.N2, MI060-4QN.05.N3, MI060-4QN.05.N4

In the case of motors with a quality mark (see rating plate), please note the related specifications depending on the application location!

1.2 Structure of the assembly instructions

Before installation and start-up, read this assembly instructions carefully to ensure correct use!

We emphasize that these assembly instructions apply to specific units only, and are in no way valid for the complete system!

Use these assembly instructions to work safely with and on the device. They contain safety instructions that must be complied with as well as information that is required for failure-free operation of the device.

Keep these assembly instructions together with the device. It must be ensured that all persons that are to work on the device can refer to the assembly instructions at any time. Keep the assembly instructions for continued use. They must be passed-on to all successive owners, users and final customers.

1.3 Target group

The assembly instructions address persons entrusted with planning, installation, commissioning and maintenance and servicing and who have the corresponding qualifications and skills for their job.

1.4 Exclusion of liability

Concurrence between the contents of these assembly instructions and the described hardware and software in the device has been examined. It is still possible that non-compliances exist; no guarantee is assumed for complete conformity. To allow for future developments, construction methods and technical data given are subject to alteration. We do not accept any liability for possible errors or omissions in the information contained in data, illustrations or drawings provided.

ZIEHL-ABEGG SE is not liable for damage due to misuse, incorrect use, improper use or as a consequence of unauthorized repairs or modifications.

1.5 Copyright



These assembly instructions contain copyright protected information. The assembly instructions may be neither completely nor partially photocopied, reproduced, translated or put on data medium without previous explicit consent from ZIEHL-ABEGG SE. Infringements are liable for damages. All rights reserved, including those that arise through patent issue or registration on a utility model.

2 Safety instructions

This chapter contains instructions to prevent personal injury and property damage. These instructions do not lay claim to completeness. In case of questions and problems, please consult our company technicians.

2.1 Explanations of symbols

Safety instructions are highlighted with warning triangles and are depicted according to the degree of hazard as follows.

	<p>Attention! General hazardous area. Death or severe injury or significant property damage can occur if the corresponding precautions are not taken!</p>
	<p>Danger due to electric current Danger by dangerous, electric voltage! Death or severe injury can occur if the corresponding precautions are not taken!</p>
	<p>Information Important additional information and advice for user.</p>

2.2 Product safety

The device conforms to the state of the art at the time of delivery and is fundamentally considered to be reliable. The device and its accessories must only be used in a flawless condition and installed and operated in compliance with the assembly instructions and/or operating instructions. Operating outside the device's technical specifications (see name plate and attachment / technical data) can lead to a defect in the device and additional damage!



Information

A separate fault and performance monitoring-system with an alarm signal function is necessary in order to prevent personal injuries and material damages during malfunctions and in case the device fails. Substitute operation must be taken into consideration! The design and installation of the system must comply with local regulations and directives.

2.3 Requirements placed on the personnel / due diligence

Persons entrusted with the planning, installation, commissioning and maintenance and servicing in connection with the frequency inverter must have the corresponding qualifications and skills for these jobs.

In addition, they must be knowledgeable about the safety regulations, EU/EC directives, rules for the prevention of accidents and the corresponding national as well as regional and in-house regulations. Personnel to be trained or instructed and apprentices are only permitted to work on the device under the supervision of an experienced person. This also applies to personnel undergoing general training. Comply with the legal minimum age.

2.4 Work on the device



Information

Mounting, electrical connection, and start-up operation may only be carried out by an electrical specialist in accordance with electrotechnical regulations (e.g. EN 50110 or EN 60204)!



Danger due to electric current

- It is generally forbidden to carry out work on electrical live parts!
- The 5 electrical safety rules must be observed!
- The safe isolation from the supply must be checked using a **two-pole** voltage detector.
- Opening of motor is prohibited. Loosening the screws will void the warranty!
- Any faults detected in the electric system/modules/operating equipment must be corrected immediately. If these faults are not corrected, the device/system is potentially very dangerous. The device/system must therefore not be operated when it is faulty.
- Fuses must always be only replaced; never repaired or bridged. The specifications for the maximum series fuse must always be adhered to (📄 Technical data). Only fuses cited in the electrical circuit diagram may be used.



Attention, automatic restart!

- The motor may switch on and off automatically for functional reasons.
- Automatically restart after a power failure or mains disconnection!
- Wait for the motor to come to a complete standstill before approaching it!



Risk of entanglement!

Do not wear loose or hanging clothing, jewellery, etc., tie together long hair and cover it.

3 Product overview

3.1 Application operational area

The fans / motors are not ready-for-use products, but conceived as components for ventilation systems (type designation see rating plate). The fans / motors may only then be operated when they are installed in accordance with their intended use, and safety has been secured through protective devices in accordance with EN ISO 13857 (EN ISO 12100) or other structural protective measures.



Attention!

The transfer of solids or solids content in the transfer medium is not permissible!

The motors are approved for use in potentially explosive areas of category 3G (Zone 2) in accordance with Directive 2014/34/EU with type of protection "nA" (non-sparking device) in accordance with EN 60079-15.

The prerequisite is that the installation is done in accordance with these assembly instructions!

- Marking dependent on temperature class T4 or T5 (see rating plate):
 - II 3G nA IIA T4
 - II 3G nA IIA T5

Example for motor rating plate



- Please make sure that the "Ex" symbol is printed in the hexagon on the motor rating plate, and that the device category and type of protection match the system requirements. Otherwise the motor must not be used!
- The temperature class specified on the rating plate must be higher than or equal to the temperature class of the explosive gas that may escape.

3.2 Functional description

ECQ motors from ZIEHL-ABEGG are highly efficient, electronically commuted motors (EC) with an integrated controller. They are designed exclusively for driving axial fans. The motors are designed for continuous operation (S1-operation) and are thermally protected.

Depending on version motors with a fixed speed or motors with three speeds (☞ rating plate).

Motors with three speeds

- Three pre-programmed speeds are possible (☞ rating plate) which are activated depending on the connection of the additional control input at “L1” or “N”.
- With the “Motor Programmer” (accessory) and a PC with the appropriate software, individual speeds and the rotation direction can be programmed.

Possible rotating directions

- CCW (counter-clockwise rotation) = left-hand direction of rotation looking at the motor shaft
- CW (clockwise rotation) = right-hand direction of rotation looking at the motor shaft

3.3 Motor protection

The motor has devices to protect it from overloading, these include protection in case of blocked rotor and overload protection with running motor.

On exceeding the maximum permissible operating temperature, this can lead to stopping of the motor and can cause permanent damage!

3.4 Transport, storage



Attention!

- Use the original packaging materials when transporting the device.
- Do not transport the fan by the connecting cable!
- Avoid shocks and impacts to the device during the transport.
- Avoid extreme humidity, heat or exposure to cold (☞ Technical Data).
- Pay attention to possible damage of the packaging or the equipment.
- Store the fan / motor in the original packaging in a dry area protected from the weather and protect it from dirt and weather until final installation.
- Protect the motor against ultraviolet radiation.
- Avoid prolonged storage; we recommend a maximum of one year (consult the manufacturer before starting if stored for longer).
- Inspect the bearing for proper operation prior to installation.

3.5 Disposal / recycling



Disposal must be carried out professionally and in an environmentally friendly way in accordance with the respective national legal stipulations.

- ▷ Separate the materials by type and in an environmentally friendly way.
- ▷ If necessary, commission a specialist company with the waste disposal.

4 Installation

4.1 Mounting the motor



Attention!

- Check the device for damage, e.g. cracks, dents or damage to the electric cables, before assembly. Start-up is not allowed in the case of transport damage!
- Mounting is only to be undertaken by trained service personnel. The system manufacturer or the machine builder and/or the user is responsible that the inherent installation and security information are harmonized with the valid standard and guidelines (EN ISO 12100 / 13857).
- The custom designs must suit the prevailing conditions.
- During assembly of the fan impellers or other components, no inadmissible pressure may be applied to the motor bearing.
- If the motor is used to drive fan impellers or other components, please note the maximum permissible speeds of the impeller or the component to be driven.
- The maximum permissible mass of the impeller or the component to be driven is 0.3 kg. Greater masses must be inquired about at ZIEHL-ABEGG and confirmed in writing.
- Tighten the fastenings with the specified torques.
- The motor must be installed in a housing which has a protection class of at least IP20 and guarantees protection against ultraviolet radiation and electrostatic charge.
- The motor must be installed so that the motor body cannot be accessed directly by the end user. This is normally achieved by means of a protective grille, screening or barriers resulting from the application.
- The housing must meet the mechanical requirements of the applicable standards and regulations. Please refer to IEC 60079-0 section 26.4.2.
- When being used as a fan drive in a potentially explosive area, the fan design must also meet the applicable explosion protection standard, e.g. distances, material pairs, etc.

Dimensions [mm]

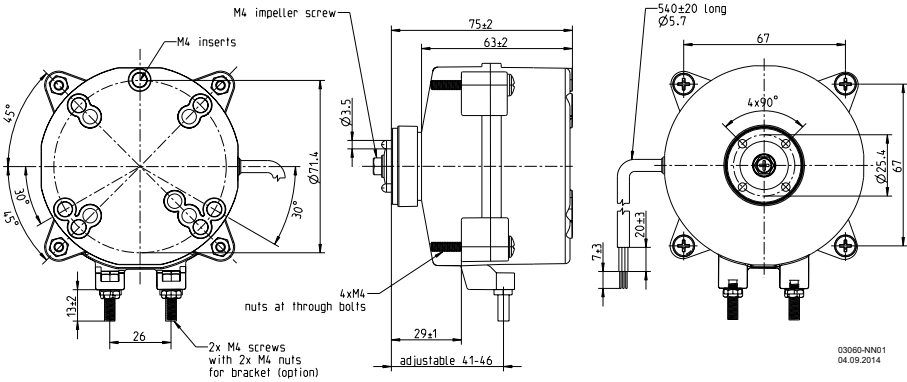

03060-NN01
04.09.2014

Tightening torque of fixings:

M4 nuts at through bolts: 1.2 – 1.6 Nm

M4 impeller screw: 1.2 – 1.6 Nm

M4 insert nuts: 1.1 - 1.5 Nm; screw depth max. 5.5 mm

M4 nuts for bracket: 1.2 – 1.6 Nm

4.2 Connection lead & terminal box



Information

- The connection of the line ends to the outer circuits must either be done outside the potentially explosive area or in an explosion-proof junction box with type of protection “n”.
- In demanding environments (wet areas, open air installation) all connections must incorporate water drainage curves. To ensure that water cannot penetrate through to the controller housing from the connections install a terminal box lower than the motor.

4.3 Connection of the motor



Danger due to electric current

- The mains voltage must comply with the EN 50160 quality characteristics and the defined standard voltages in IEC 60038!
- Connect fan only to electrical circuits that can be disconnected with an all-pole isolating switch.
- The device owner is responsible for the EMC of the entire plant according to the locally applicable standards.

Connection diagram for motors with one speed

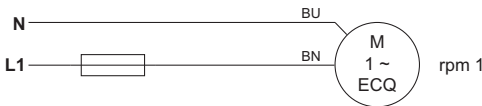

KT00047B
18.11.2015

N, L1 Line voltage see rating plate
BN brown
BU blue

Connection diagram for motors with three speeds

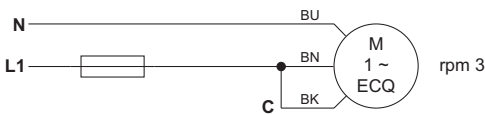

If the black wire is connected with the brown wire, the motor runs at speed step 3

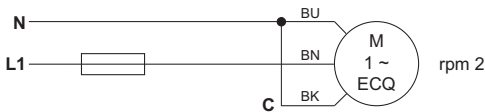

If the black wire is connected with the blue wire, the motor runs at speed step 2

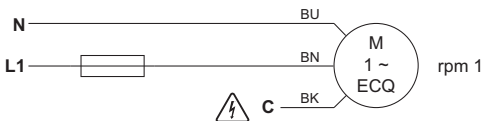

If the black wire is not connected, the motor runs at speed step 1

KT00047A
14.04.2016

N, L1 Line voltage see rating plate
C Control input speed
BK black
BN brown
BU blue
rpm 3 Speed step 3
rpm 2 Speed step 2
rpm 1 Speed step 1

**Danger due to electric current**

- Connection to the 3 ~ 230 V line between two phases is not permitted!
- A dangerous voltage (maximum line voltage) is applied at the **black** connecting wire (speed control input) when it is not used (speed 1). Therefore this wire must be connected to a terminal for insulation.

5 Start-up

**Attention!**

- Before first-time start-up, check the following:
 1. Installation and electrical connection have been properly completed?
 2. Connection data complies with the specifications on the rating plate?
 3. That any installation remnants and foreign bodies that may be present have been removed.

**Attention!**

- Commissioning may only take place if all safety instructions have been checked and danger can be excluded.
 - Check direction of rotation.
 - Check for quiet, low vibration operation. Strong vibrations due to erratic operation (unbalanced), e.g. caused by transportation damage or improper use, can lead to failure.

6 Service work

6.1 Repairs / maintenance

**Attention!**

- Observe the safety information!
- No maintenance work at running motor!
- First ensure before working on the motor/fan that a potentially explosive atmosphere is no longer present. Then disconnect the voltage supply to the motor and secure against being switched back on.
- Regular inspection, if necessary with cleaning, is necessary to prevent imbalance due to ingress of dirt.
 - Watch out for vibration free motion.
 - Maintenance interval in accordance with the degree of contamination of the impeller!
- The connecting cable may only be changed by authorised ZIEHL-ABEGG SE personnel.

**Information**

The fan or motor is maintenance-free due to the use of ball bearings with “life-time lubrication”. The grease service life (☞ Technical data) may be lower than the theoretical value stated there (F_{10h}) if particular operating conditions such as vibrations, humidity or soiling in the bearing, unfavourable control modes, etc. are present.

6.2 Cleaning

**Danger due to electric current**

- First ensure before working on the motor/fan that a potentially explosive atmosphere is no longer present. Then disconnect the voltage supply to the motor and secure against being switched back on.
- Do not use any aggressive cleaning agents when cleaning.
- Make sure that no water gets into the inside of the motor and electronics.

7 Enclosure

7.1 Technical data

Line voltage* (☞ rating plate)	1 ~ 230 V, 50/60 Hz 1 ~ 120 V, 50/60 Hz
Power consumption (P1)	Version with one speed: max 18 W
	Version with three speeds: max. 34 W
Power output (P2)	Version with one speed: max 9 W
	Version with three speeds: max. 20 W
Speed step 3 / 2 / 1	see rating plate
Maximal line fuse	4 A
Max. load limit integral of cut-in current approx.	0.118 A ² s
Permissible minimal and maximal ambient temperature for operation	-30...+50 °C
Permissible temperature range for storage and transport	-40...+80 °C
Permissible rel. humidity	85 % no condensation
Electromagnetic compatibility for the standard voltage 230 / 400 V according to IEC 60038	Interference emission according to EN 55014-1 (domestic household applications)
	Interference immunity according to EN 61000-4-4 (industrial applications)
Harmonics current	In accordance with EN 61000-3-2
	Please ask manufacturer for the individual harmonic oscillation levels of the current as a percentage of the fundamental oscillation of the rated current.
Ball bearings grease service-life (F _{10h})	The device is designed with a life time for the bearings and a bearings service-life of at least 40.000 h when S operated at full power in the maximum permissible ambient-temperature environment.
Connection cable	Version with one speed: H03VV-F 2 x 0.5 mm ²
	Version with three speeds: H03VV-F 3 x 0.5 mm ²
Thermal class	THCL130
Safety class	II
Protection class of motor according to EN 60529	IP55
Weight	see rating plate

For motors with corresponding quality mark, marking dependent on temperature class T4 or T5 (see rating plate)

ATEX approval		II 3G nA IIA T4 II 3G nA IIA T5
---------------	---	------------------------------------

For motors with one speed and corresponding quality mark (see rating plate)		
Authorization:	FILE No. E347018	UL 1004-7
		Electronically-Protected Motor - Component

For motors with three speeds and corresponding quality mark (see rating plate)		
Authorization:	FILE No. E123518	UL 1004-3
		Thermal-device-protected Motor - Component

7.2 **EU declaration of conformity**

- Translation -
(english)

ZA97ex-GB 1616 Index 001

Manufacturer: ZIEHL-ABEGG SE
Heinz-Ziehl-Straße
74653 Künzelsau
Germany

The manufacturer is solely responsible for issuance of the declaration of conformity.

The products:

- Internal rotor motors MI060-4QN.05.N1, MI060-4QN.05.N2, MI060-4QN.05.N3 and MI060-4QN.05.N4
as electrical equipment of Group IIA for potentially explosive areas of Zone 2, type of protection "nA"

The engine type:

- Electronically commutated internal rotor motor with integrated EC controller

These products comply with the following EU directives:

- EMC Directive 2014/30/EU
- Low Voltage Directive 2014/35/EU
- ATEX Directive 2014/34/EU

The following harmonised standards have been used:

EN 55014-1:2006 + A1:2009 + A2:2011
EN 55014-2:2015
EN 61000-3-2:2014
EN 61000-4-4:2012
EN 61000-4-5:2014
EN 61000-4-11:2004

EN 60335-1:2012 + A11:2014 + AC:2014
EN 60335-2-24:2010
EN 60335-2-89:2010

EN 60079-0:2012 + A11:2013
EN 60079-15:2010

Compliance with the EMC Directive 2014/30/EU and the ATEX Directive 2014/34/EU only applies to these products if they have been connected and installed according to the assembly and operating instructions. If these products are integrated into a system or completed and operated with other components (e.g. controllers or control devices), then the manufacturer or operator of the complete system is responsible for compliance with the EMC Directive 2014/30/EU and the ATEX Directive 2014/34/EU.

Künzelsau, 20.04.2016
(location, date of issue)

ZIEHL-ABEGG SE
Dr. W. Angelis
Technical Director Air Movement Division
(name, function)

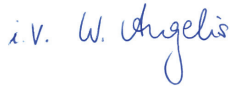

(signature)

7.3 Manufacturer:

Our products are manufactured in compliance with valid international standards and regulations.

If you have any questions about how to use our products or if you are planning special applications, please contact:

ZIEHL-ABEGG SE
Heinz-Ziehl-Straße
D-74653 Künzelsau
Phone 07940/16-0
Fax 07940/16-300
info@ziehl-abegg.de

7.4 Service address

Please refer to the homepage at www.ziehl-abegg.com for a list of our subsidiaries worldwide.